

رزومه تصویری زهرا داودی

شماره تماس:

۰۹۰۳۳۸۸۶۵۶۴





لوگو





لوگو

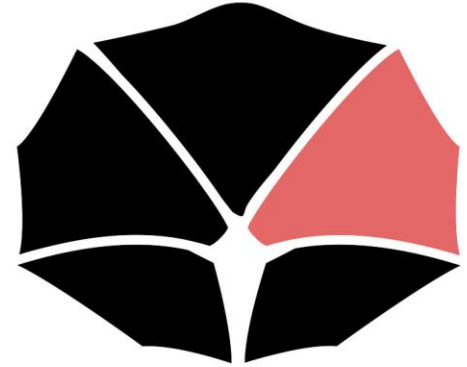



لوگو

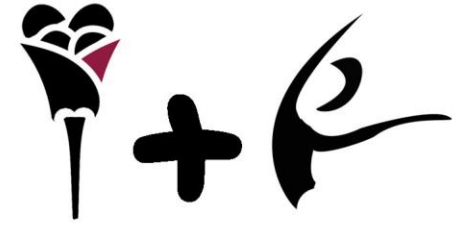



طراحی جلد



مهر ایران

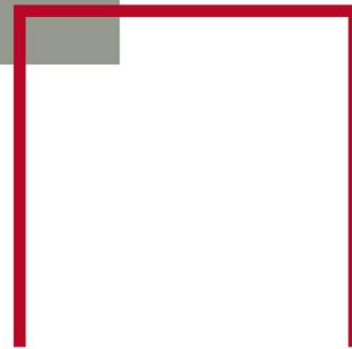
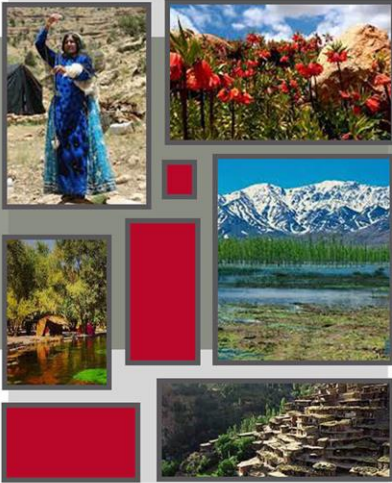



طراحی جلد





طراحی جلد

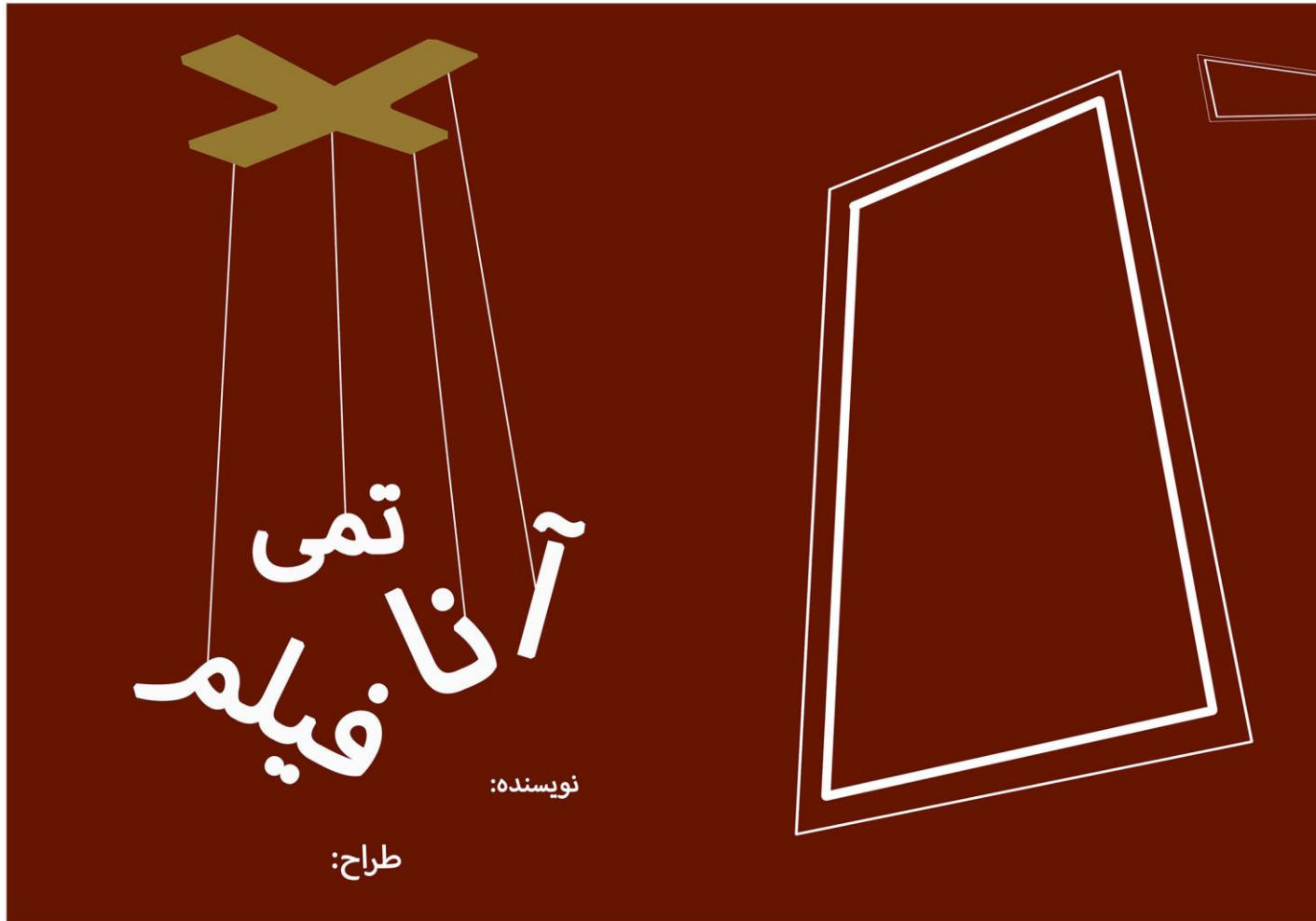



پوستر

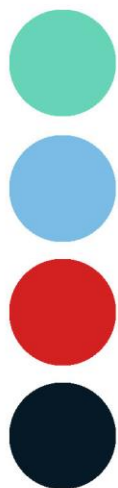



پوستر

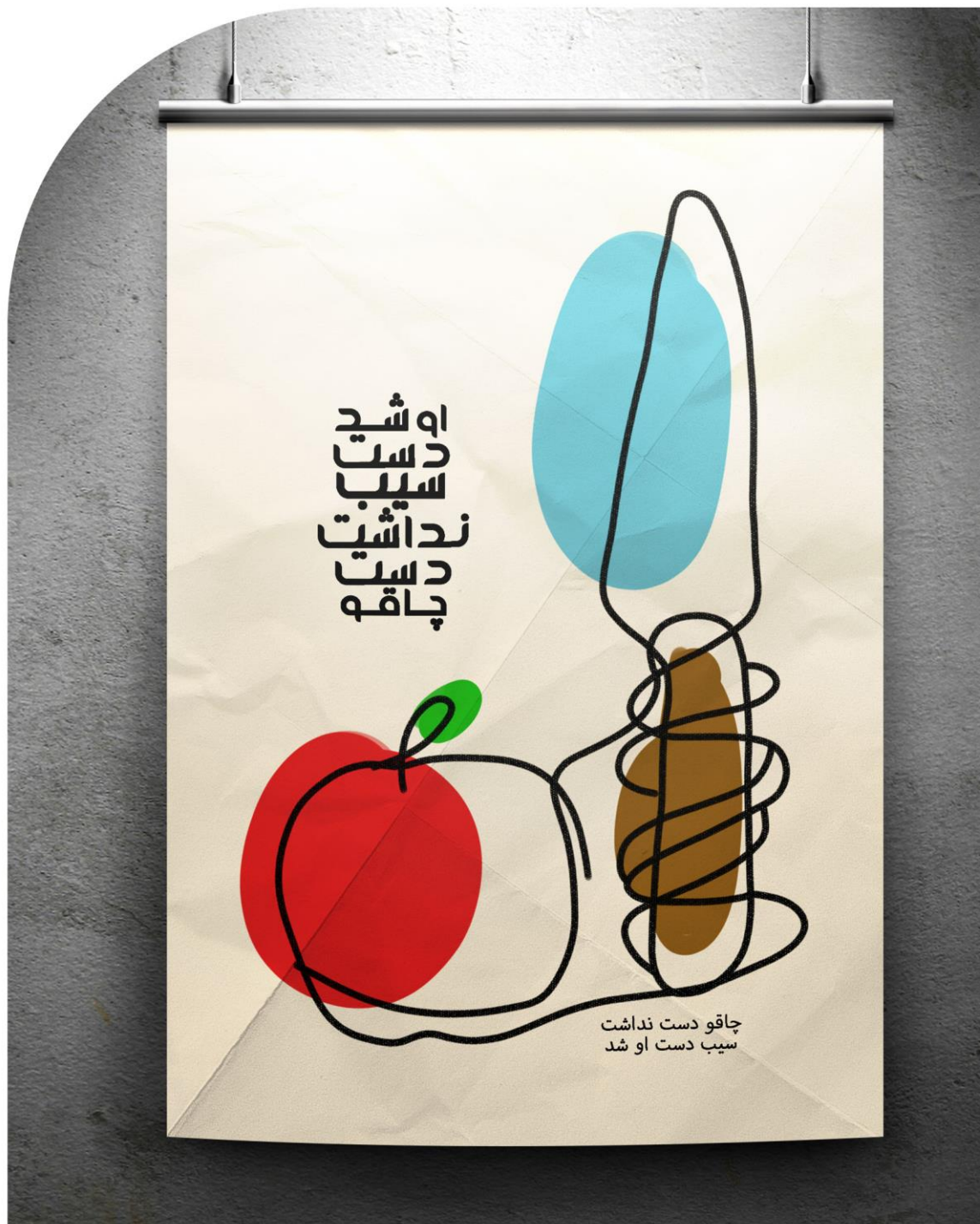

پوستر



پوستر





بسته بندی

schön

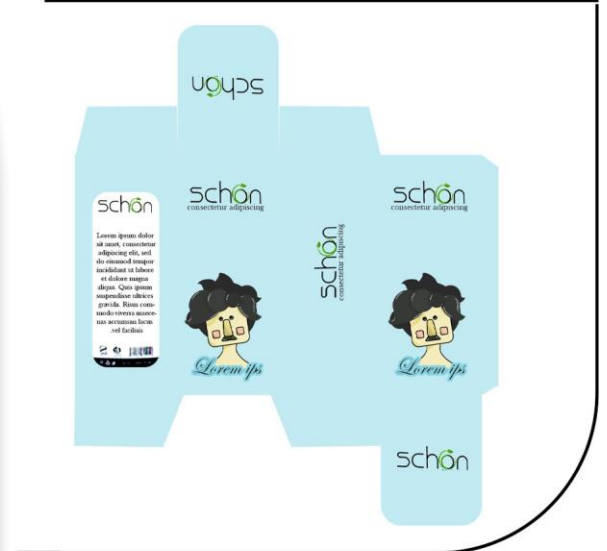
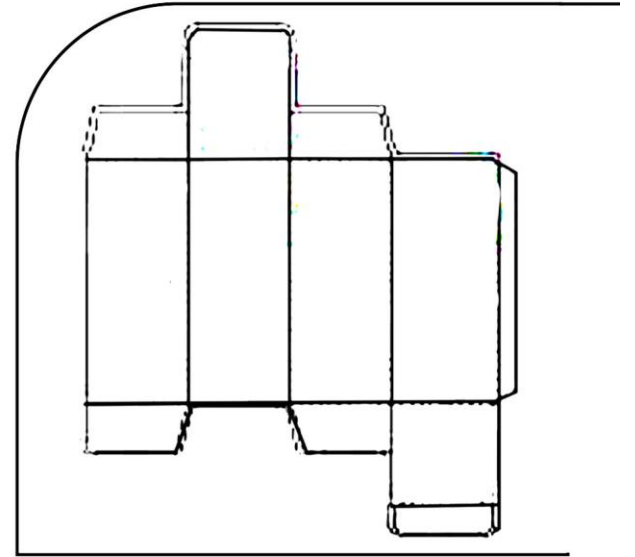



بسته بندی

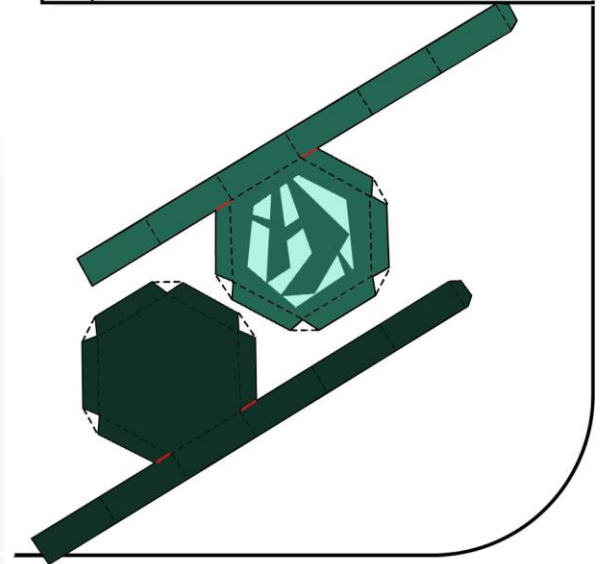
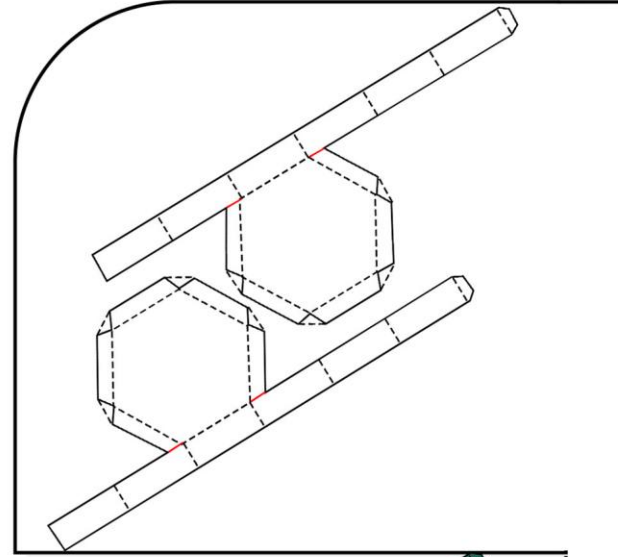



بسته بندی

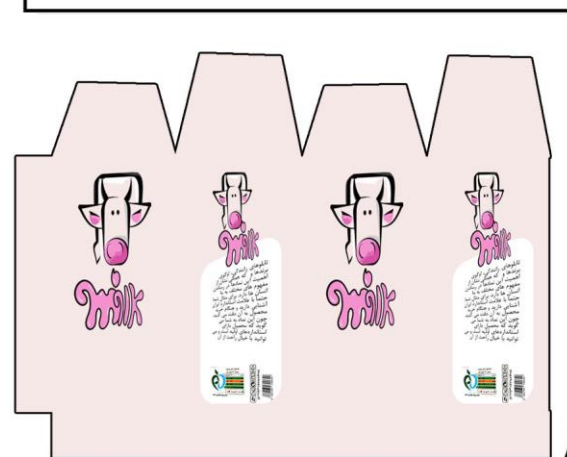
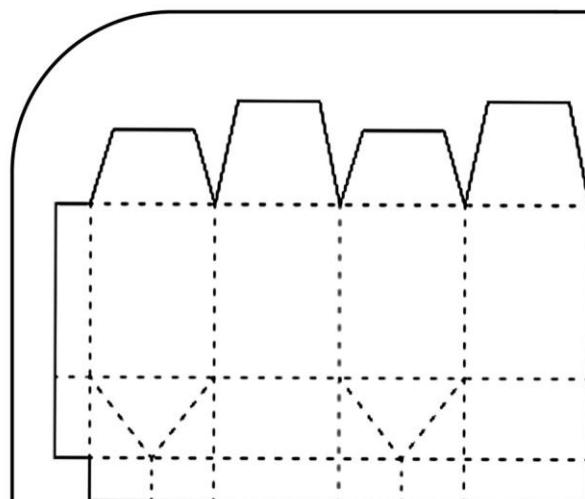



بسته بندی

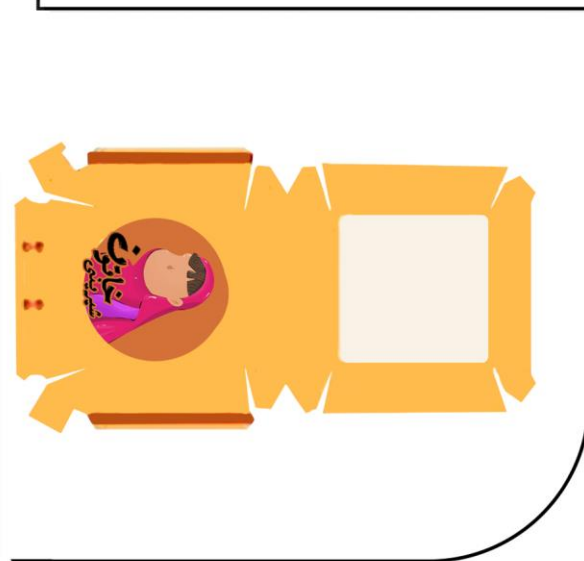
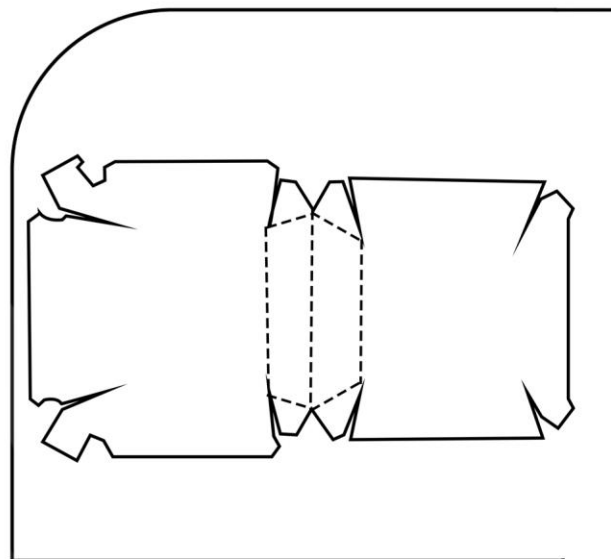



طراحی کاراکتر و فضا

تولید استدیو دوران

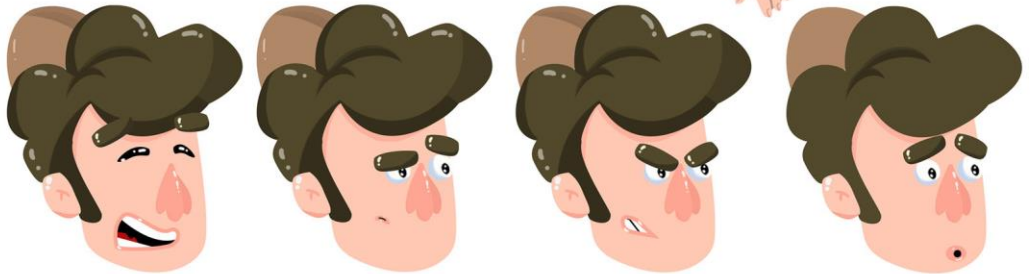
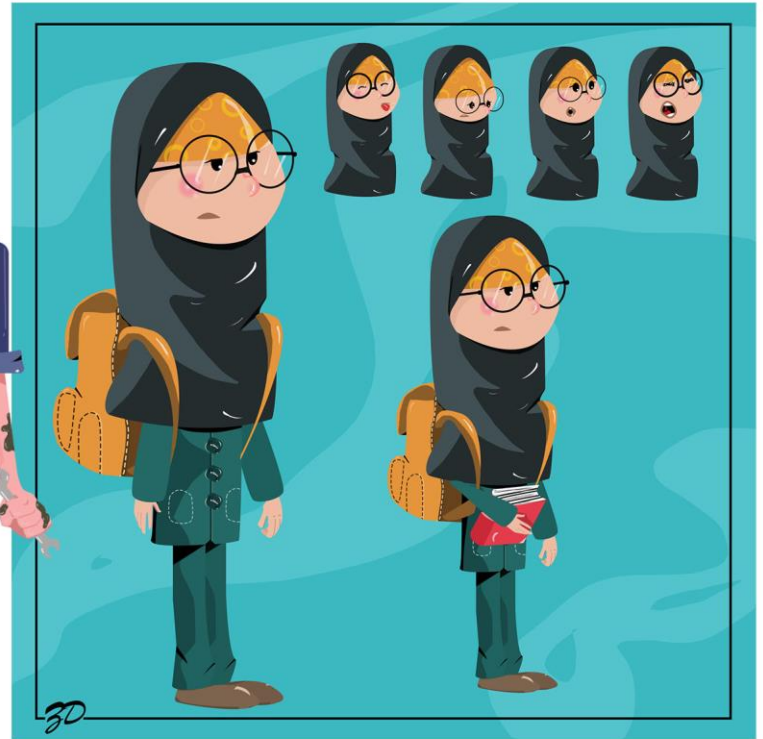



طراحی کاراکتر و فضا

تولید استدیو دوران





هویت بصری

